

Data Sheet



Article number: 0125067

Description: Retaining ring SP50
Spring steel

Measures

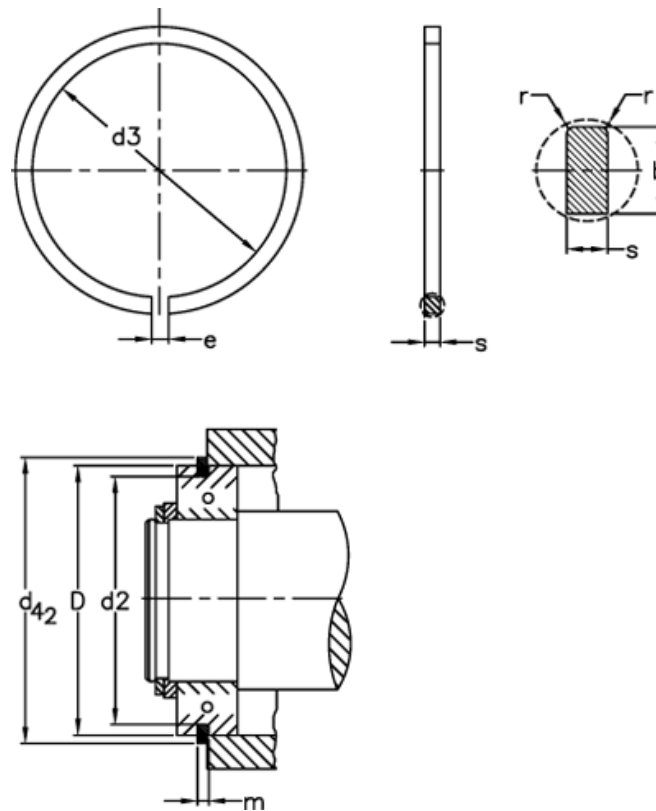

b	= 4.04	FRg kN	= 2.60	tol	= -0.15
D	= 50	FR kN	= 13.3	tol	= -0.1
d2	= 47.60	g	= 2.0	tol	= -0.25
d3	= 46.7	K kN-mm	= 24.3	tol	= 0.3
d42	= 55.7	m	= 1.35	tol	= 0.5
Description	= SP 50	n abl x 1000	= 6.0	Weight kg/1000	= 5.8
e	= 4	r min	= 0.4		
FN kN	= 30.6	s	= 1.12		